

SOLDADURA ALUMINOTÉRMICA

145.00€

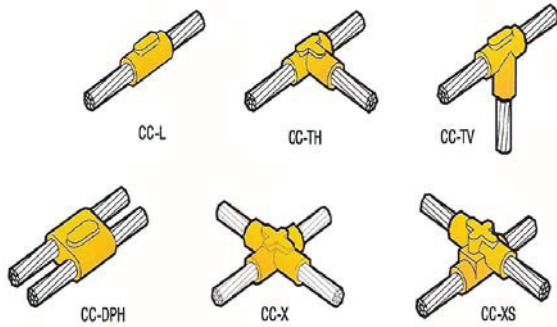

CABO/CHAPA

150.00€

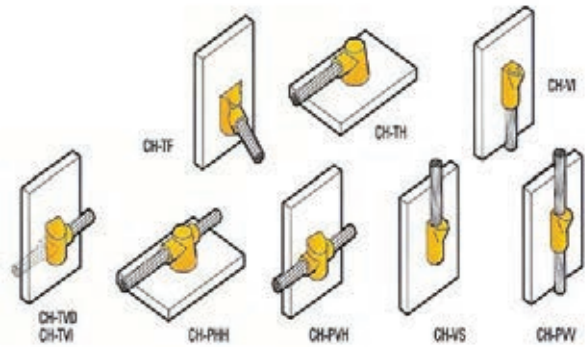

CABO/ELECTRODO

145.00€

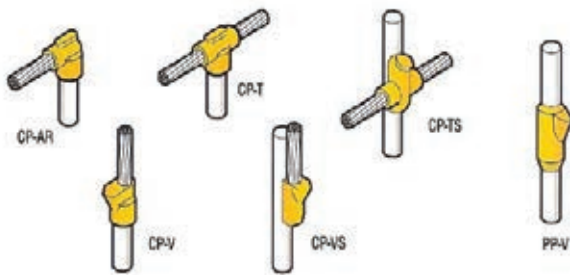

CABO/BARRA

150.00€

CABO/TUBO

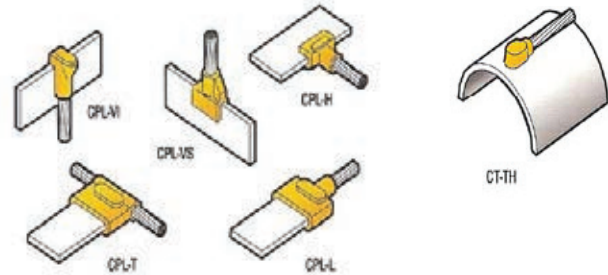

CABO/HELIÃO

145.00€

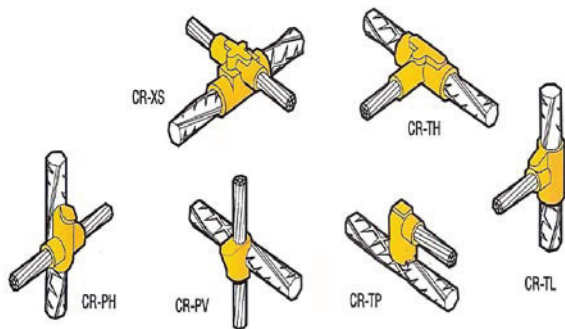

BARRA/BARRA

150.00€

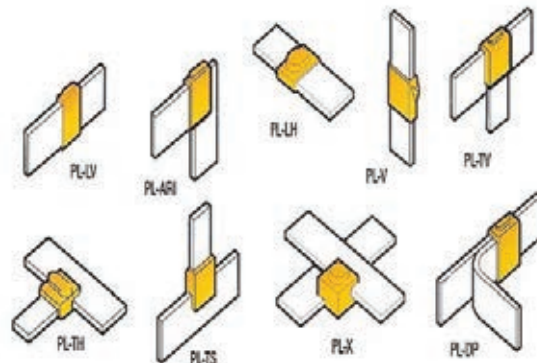

CÓDIGO

REFERÊNCIA

13.004.001	CARTUCHO C-45
13.004.002	CARTUCHO C-65
13.004.003	CARTUCHO C-90
13.004.004	CARTUCHO C-115
13.004.005	CARTUCHO C-150
13.004.006	CARTUCHO C-200
13.008.001	PINÇA TS-C 80
13.009.001	RASPADOR R-90
13.009.003	RASPADOR R-45
13.010.001	ACENDEDOR KLK
13.011.001	MASSA VEDAÇÃO
27.009.001	ESCOVA LIMPEZA

Preços sob consulta para moldes com secções superiores a 95mm.



SOLDADURA ALUMINOTÉRMICA



KR



KR-30



KU



KB

CÓDIGO	REFERÊNCIA	Ø MÁX ELECTRODO MM	CABO MIN	CONDUTORES ADMISSIVEIS		
				MM MÁX	Ø CABO MIN	MM MÁX
99.001.030	NORMAL	16	10	70	4	11
13.002.001	KR-1	16	10	70	4	11
13.002.002	KR-2	20	25	95	6	13
13.002.004	KR-30	20			barra	30x6
		16			barra	30x10
13.007.001	KU-1616	15	16	35	4	6
13.007.003	KU-1625	16	25	70	6	11
13.007.006	KU-2025	20	25	70	6	11
13.007.004	KU-1663	16 e 20	70	95	10	13
13.007.002	KU-2012	20	95	185	12	18
13.007.005	KB-1625	16 e 20	25	70	6	11
13.002.005	KB-1663	16 e 20	70	95	10	13
13.007.008	KB-2012	20	95	185	12	18

SOLDADURA ALUMINOTÉRMICA



KR



KR-30



KU

CÓDIGO	REFERÊNCIA	Ø MÁX ELECTRODO MM	CABO MIN	CONDUTORES ADMISSIVEIS		
				MM MÁX	Ø CABO MIN	MM MÁX
13.007.009	KBL-25	M8X35	25	70	6	11
99.002.049	KBL-63	M10X45	70	95	10	13
13.002.006	KBL-125	M10X55	95	185	12	18
13.002.007	KBH-25	M8X35	25	70	6	11
13.002.008	KBH-63	M10X45	70	95	10	13
13.002.009	KBH-125	M10X55	95	185	12	18
13.002.010	KDP-50	M8X30	16	50	4	9
13.002.011	KDP-95	M8X35	25	95	6	13
13.002.012	KDP-150	M10X40	35	150	7	16
13.002.013	KDP-240	2 M8X45	95	240	12	20

LIGADOR AMOVIVEL

Permite efetuar medição de resistências de terras.

CÓDIGO	REFERÊNCIA	COMP.
99.005.003	AMOVIVEL SIMPLES	30X5X125-M8
99.005.004	AMOVIVEL DUPLO	30X5X180-M8



Outras medidas de amovíveis sob consulta.